

AVVOLGIBILE IN ACCIAIO COIBENTATO CON POLIURETANO **MEDIA DENSITÀ** **C 42 MIGNON**



Tempo di consegna:
5 giorni lavorativi

BLOCCAGGIO STECCA



STANDARD
CON TAPPO
LATERALE
SPILLATO

Profilo in acciaio per avvolgibile a schiuma poliuretana ecologica ad alta stabilità e lunga durata.

CARATTERISTICHE TECNICHE

- **DIMENSIONE PROFILO**
9 x 42 mm
- **PESO PER MQ**
c.ca 10,0 Kg
- **SPESSORE ACCIAIO**
0,40 mm
- **BARRE PER 1MT
DI ALTEZZA**
23
- **LARGHEZZA MASSIMA
CONSENTITA**
3500 mm

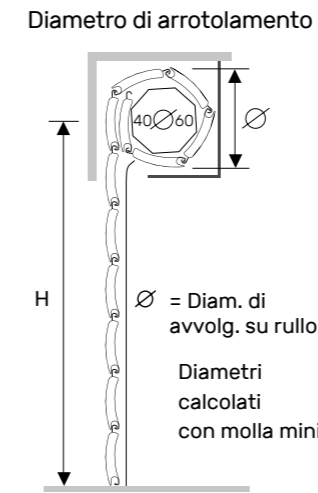

	Su rullo ø 40	Su rullo ø 60
altez. telo -> diametro	altez. telo -> diametro	altez. telo -> diametro
1000 -> 115	1000 -> 115	1000 -> 115
1200 -> 120	1200 -> 120	1200 -> 125
1300 -> 125	1300 -> 125	1300 -> 125
1400 -> 130	1400 -> 130	1400 -> 130
1500 -> 135	1500 -> 135	1500 -> 135
1600 -> 140	1600 -> 140	1600 -> 140
1700 -> 145	1700 -> 145	1700 -> 145
1800 -> 150	1800 -> 150	1800 -> 150
1900 -> 160	1900 -> 160	1900 -> 155
2000 -> 165	2000 -> 165	2000 -> 160
2200 -> 170	2200 -> 170	2200 -> 165
2400 -> 175	2400 -> 175	2400 -> 170
2600 -> 180	2600 -> 180	2600 -> 175
2800 -> 185	2800 -> 185	2800 -> 180
3000 -> 185	3000 -> 185	3000 -> 185
3300 -> 190	3300 -> 190	3300 -> 190

misure in mm misure in mm

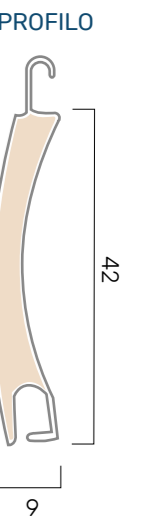

GUIDE COMPATIBILI PER NUOVE REALIZZAZIONI

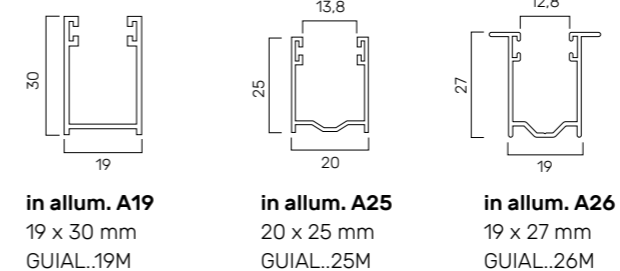

GUIDE COMPATIBILI PER SOSTITUZIONE

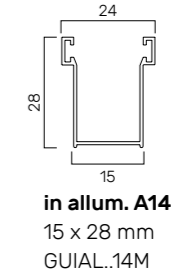

GUIDE COMPATIBILI PER CASSONETTI IN ALLUMINIO

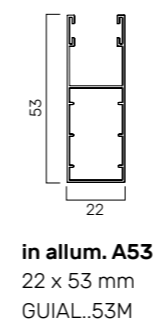

TERMINALI COMPATIBILI

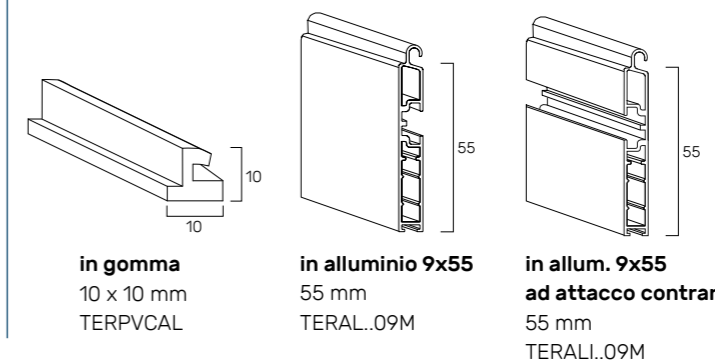

CATENACCIOLI

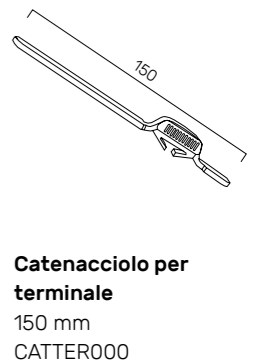

STECHE STECCE tagliate su misura TERMINALE IN GOMMA TERMINALE IN ALLUMINIO

*minimo di fatturazione per gli avvolgibili solo telo: 1,20 mq